

MIRELLA-50-W

~40° wide beam

TECHNICAL SPECIFICATIONS:

Dimensions	Ø 49.9 mm
Height	23.9 mm
Fastening	glue
Colour	metal
Box size	480 x 280 x 300 mm
Box weight	3 kg
Quantity in Box	336 pcs
ROHS compliant	yes ⓘ





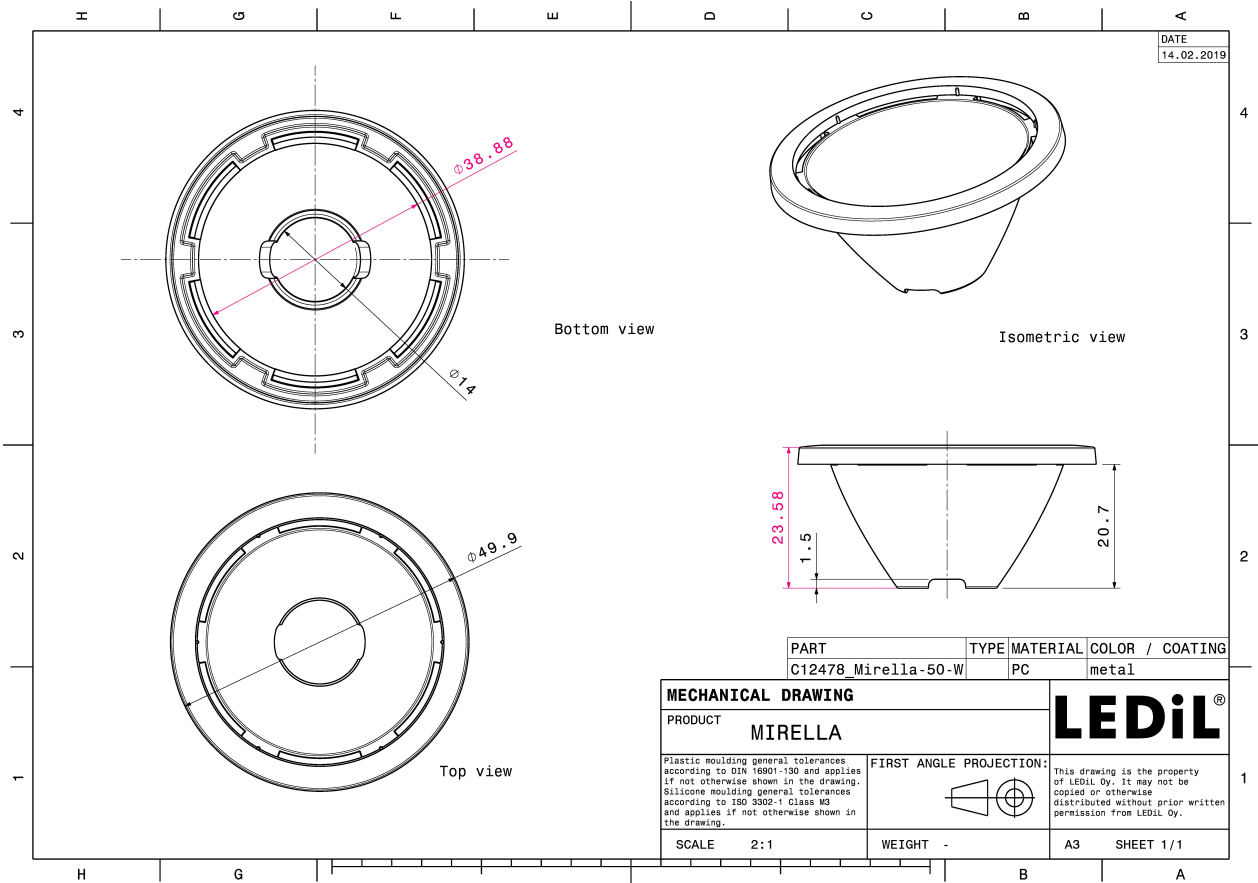

MATERIAL SPECIFICATIONS:

Component	Type	Material	Colour	Coating
MIRELLA-50-W	Reflector	PC	metal	lacquer

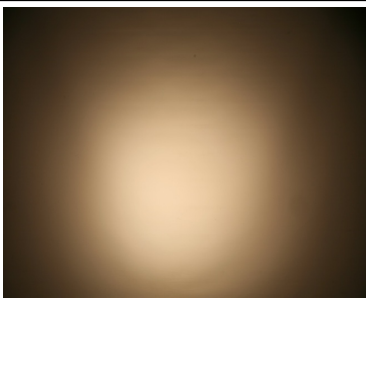
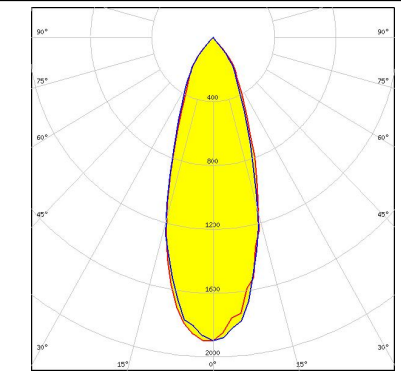
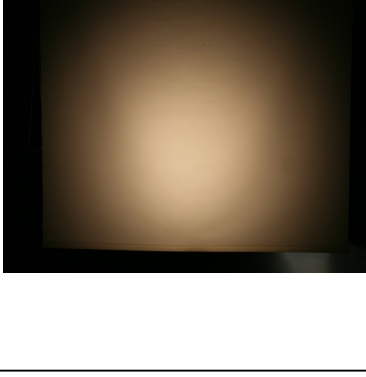
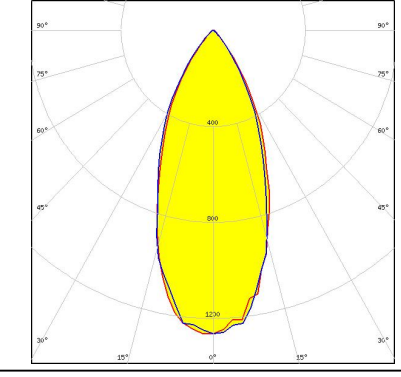

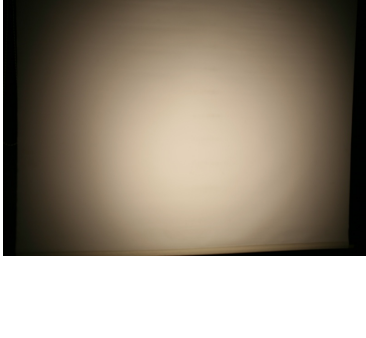
PHOTOMETRIC DATA (MEASURED):

<p>bridgelux.</p> <p>LED BXRA LS FWHM 35.0° Efficiency 88 % Peak intensity 1.900 cd/lm LEDs/each optic 1 Light colour White Required components:</p>		
<p>bridgelux.</p> <p>LED BXRA LS FWHM 43.0° Efficiency 82 % Peak intensity 1.300 cd/lm LEDs/each optic 1 Light colour White Required components: C12479_MIRELLA-DL</p>		
<p>bridgelux.</p> <p>LED BXRA LS FWHM 42.0° Efficiency 84 % Peak intensity 1.400 cd/lm LEDs/each optic 1 Light colour White Required components: C13333_MIRELLA-CL</p>		
<p>CITIZEN</p> <p>LED CLL01x FWHM 50.0° Efficiency % Peak intensity cd/lm LEDs/each optic 1 Light colour White Required components: C12479_MIRELLA-DL</p>		

PHOTOMETRIC DATA (MEASURED):

CITIZEN

LED CLL01x
 FWHM 48.0°
 Efficiency 84 %
 Peak intensity 1.200 cd/lm
 LEDs/each optic 1
 Light colour White
 Required components:
 C13333_MIRELLA-CL



CITIZEN

LED CLL01x
 FWHM 44.0°
 Efficiency %
 Peak intensity cd/lm
 LEDs/each optic 1
 Light colour White
 Required components:

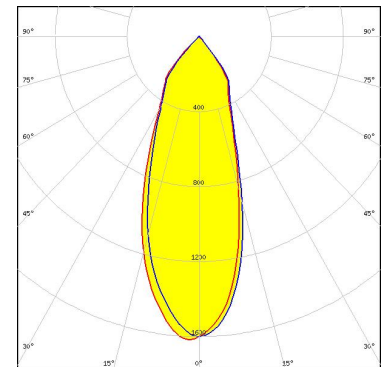
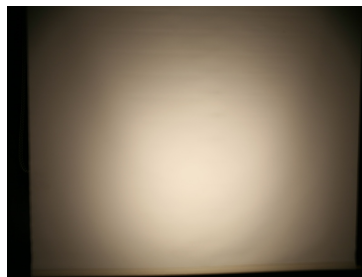

CITIZEN

LED CLL02x/CLU02x (LES10)
 FWHM 50.0°
 Efficiency 82 %
 Peak intensity 1.040 cd/lm
 LEDs/each optic 1
 Light colour White
 Required components:
 C13723_MIRELLA-RZL

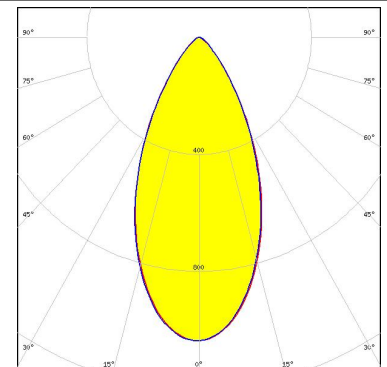
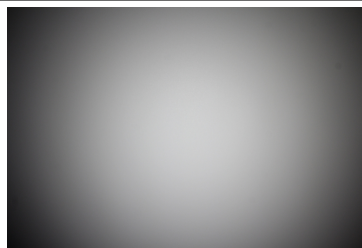

CITIZEN

LED CLL02x/CLU02x (LES10)
 FWHM 42.0°
 Efficiency 90 %
 Peak intensity cd/lm
 LEDs/each optic 1
 Light colour White
 Required components:



PHOTOMETRIC DATA (MEASURED):

CITIZEN

LED CLL02x/CLU02x (LES10)
 FWHM 48.0°
 Efficiency 82 %
 Peak intensity cd/lm
 LEDs/each optic 1
 Light colour White
 Required components:
 C12479_MIRELLA-DL



CITIZEN

LED CLL02x/CLU02x (LES10)
 FWHM 46.0°
 Efficiency 84 %
 Peak intensity 1.200 cd/lm
 LEDs/each optic 1
 Light colour White
 Required components:
 C13333_MIRELLA-CL

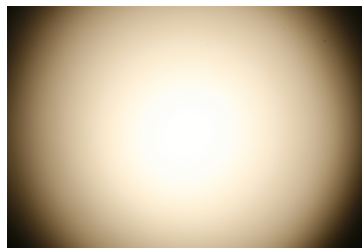

CITIZEN

LED CLL02x/CLU02x (LES10)
 FWHM 50.0°
 Efficiency 83 %
 Peak intensity 1.090 cd/lm
 LEDs/each optic 1
 Light colour White
 Required components:
 C12479_MIRELLA-DL

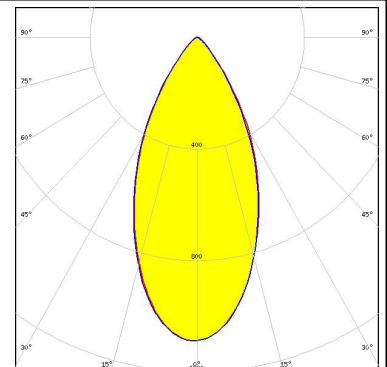
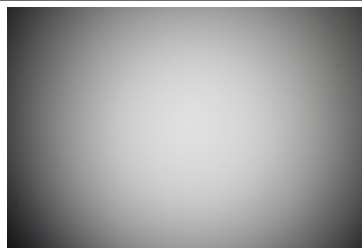

CITIZEN

LED CLU700/701
 FWHM 44.0°
 Efficiency 82 %
 Peak intensity 1.300 cd/lm
 LEDs/each optic 1
 Light colour White
 Required components:
 C13333_MIRELLA-CL

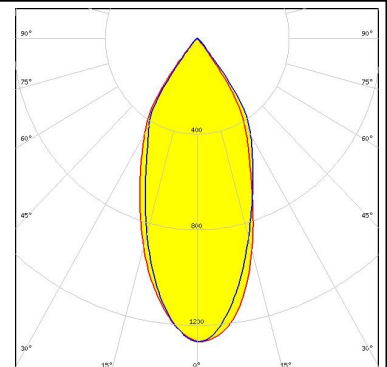
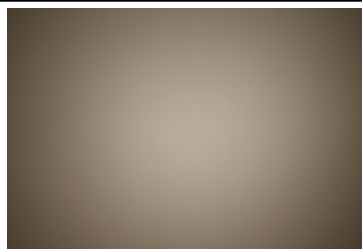

PHOTOMETRIC DATA (MEASURED):

CITIZEN

LED CLU700/701
 FWHM 46.0°
 Efficiency 80 %
 Peak intensity 1.100 cd/lm
 LEDs/each optic 1
 Light colour White
 Required components:
 C13723_MIRELLA-RZL

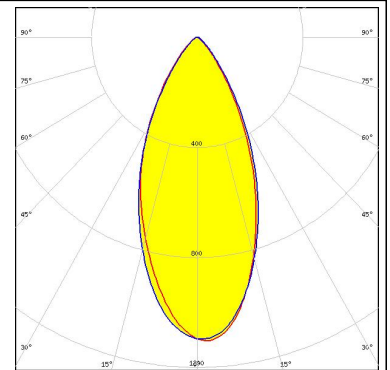

CITIZEN

LED CLU700/701
 FWHM 40.0°
 Efficiency 88 %
 Peak intensity 1.400 cd/lm
 LEDs/each optic 1
 Light colour White
 Required components:

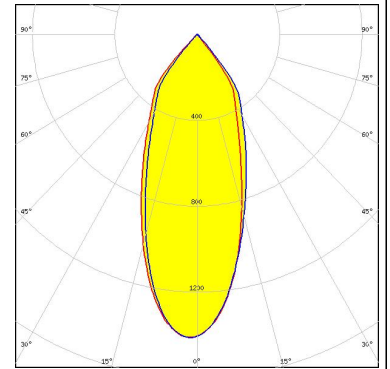
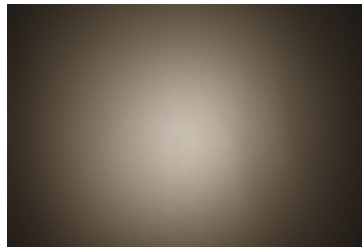

CITIZEN

LED CLU700/701
 FWHM 47.0°
 Efficiency 82 %
 Peak intensity 1.100 cd/lm
 LEDs/each optic 1
 Light colour White
 Required components:
 C12479_MIRELLA-DL

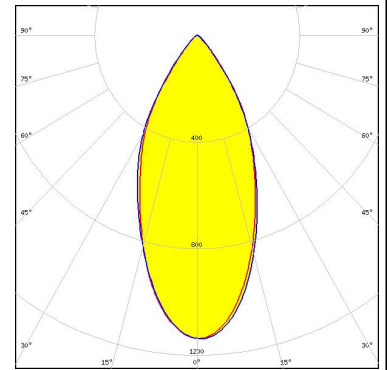
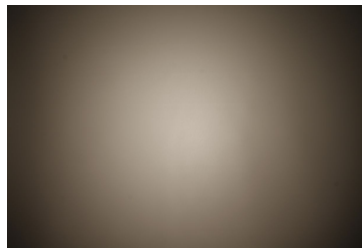

CITIZEN

LED CLU710/711
 FWHM 46.0°
 Efficiency 88 %
 Peak intensity 1.200 cd/lm
 LEDs/each optic 1
 Light colour White
 Required components:

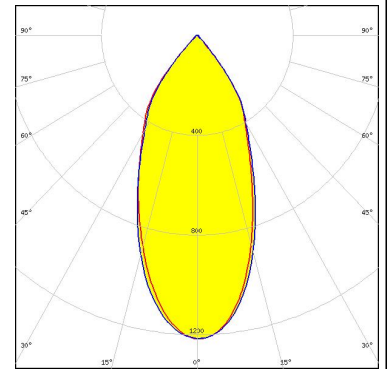
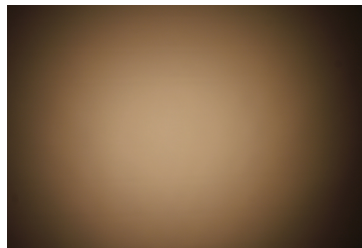

PHOTOMETRIC DATA (MEASURED):

CITIZEN

LED CLU710/711
 FWHM 48.0°
 Efficiency 83 %
 Peak intensity 1.100 cd/lm
 LEDs/each optic 1
 Light colour White
 Required components:
 C13333_MIRELLA-CL

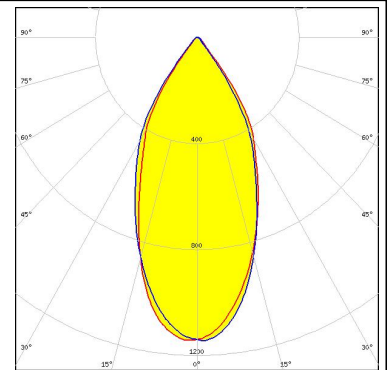
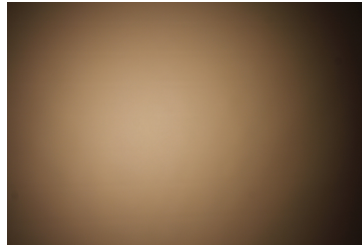

CITIZEN

LED CLU710/711
 FWHM 49.0°
 Efficiency 80 %
 Peak intensity 1.000 cd/lm
 LEDs/each optic 1
 Light colour White
 Required components:
 C13723_MIRELLA-RZL

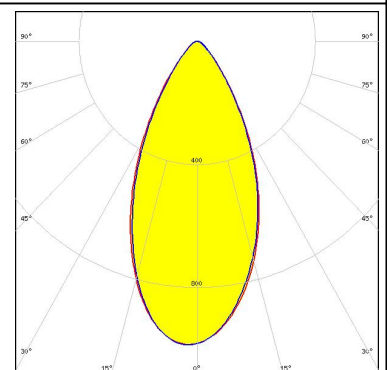
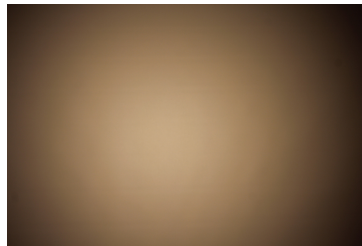

CITIZEN

LED CLU710/711
 FWHM 50.0°
 Efficiency 79 %
 Peak intensity 0.960 cd/lm
 LEDs/each optic 1
 Light colour White
 Required components:
 C12479_MIRELLA-DL

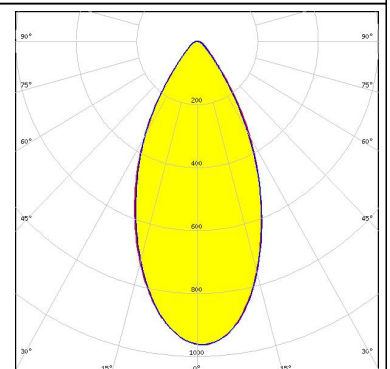
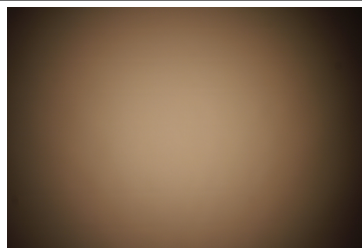

CITIZEN

LED CLU720/721
 FWHM 53.0°
 Efficiency 80 %
 Peak intensity 0.900 cd/lm
 LEDs/each optic 1
 Light colour White
 Required components:
 C13723_MIRELLA-RZL

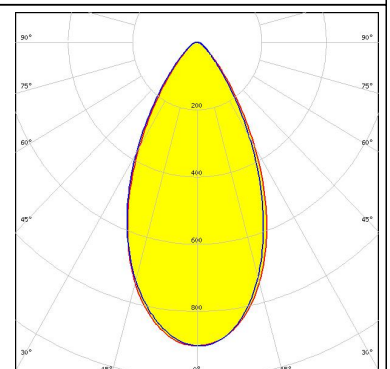
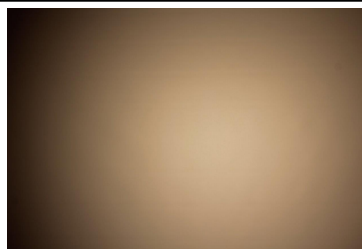

PHOTOMETRIC DATA (MEASURED):

CITIZEN

LED CLU720/721
 FWHM 53.0°
 Efficiency 79 %
 Peak intensity 0.890 cd/lm
 LEDs/each optic 1
 Light colour White
 Required components:
 C12479_MIRELLA-DL

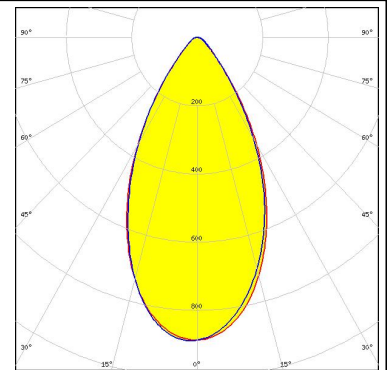
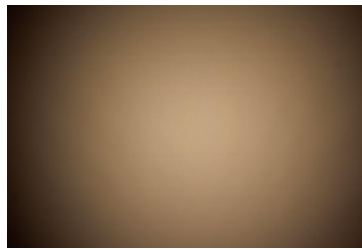

CITIZEN

LED CLU720/721
 FWHM 51.0°
 Efficiency 88 %
 Peak intensity 1.100 cd/lm
 LEDs/each optic 1
 Light colour White
 Required components:

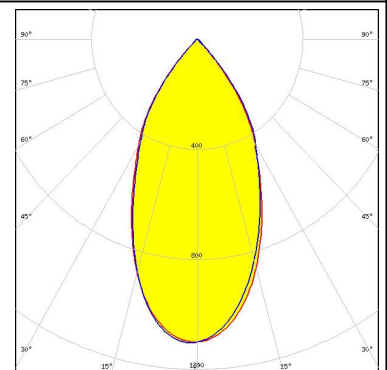
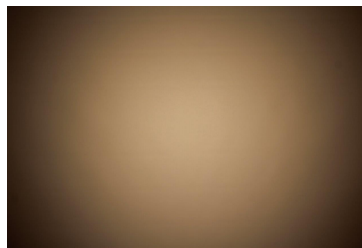

CITIZEN

LED CLU720/721
 FWHM 55.0°
 Efficiency 83 %
 Peak intensity 1.000 cd/lm
 LEDs/each optic 1
 Light colour White
 Required components:
 C13333_MIRELLA-CL

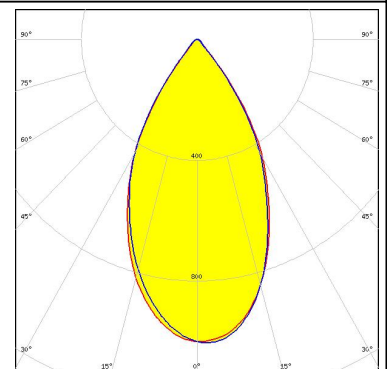
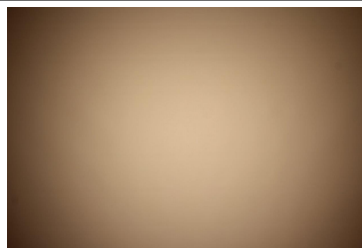

CREE

LED CXA/B 13xx
 FWHM 43.0°
 Efficiency 81 %
 Peak intensity 1.400 cd/lm
 LEDs/each optic 1
 Light colour White
 Required components:
 C12479_MIRELLA-DL

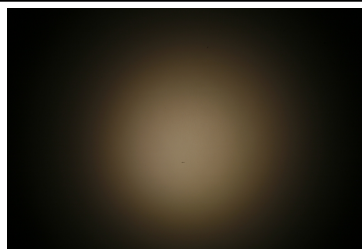

PHOTOMETRIC DATA (MEASURED):

CREE

LED CXA/B 13xx
FWHM 37.0°
Efficiency 86 %
Peak intensity 1.800 cd/lm
LEDs/each optic 1
Light colour White
Required components:



CREE

LED CXA/B 13xx
FWHM 42.0°
Efficiency 81 %
Peak intensity 1.500 cd/lm
LEDs/each optic 1
Light colour White
Required components:
C13333_MIRELLA-CL

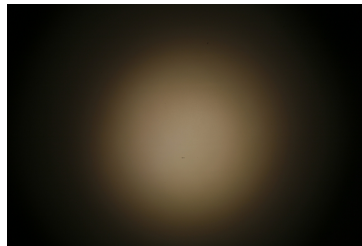

CREE

LED CXA/B 15xx
FWHM 50.0°
Efficiency 87 %
Peak intensity 1.100 cd/lm
LEDs/each optic 1
Light colour White
Required components:
C12479_MIRELLA-DL

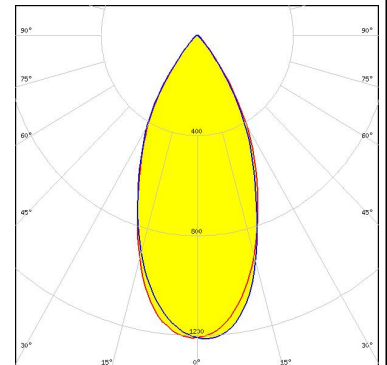
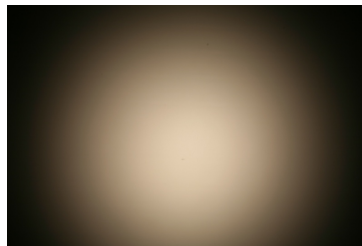

CREE

LED CXA/B 15xx
FWHM 46.0°
Efficiency 85 %
Peak intensity 1.400 cd/lm
LEDs/each optic 1
Light colour White
Required components:
C13333_MIRELLA-CL

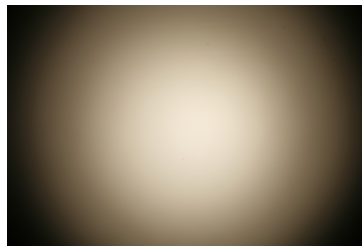

PHOTOMETRIC DATA (MEASURED):

CREE

LED CXA/B 15xx
 FWHM 42.0°
 Efficiency 91 %
 Peak intensity 1.400 cd/lm
 LEDs/each optic 1
 Light colour White
 Required components:

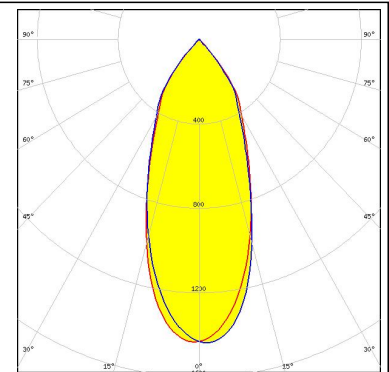

CREE

LED CXA/B 1816 & CXA/B 1820 & CXA 1850
 FWHM 56.0°
 Efficiency 82 %
 Peak intensity 1.100 cd/lm
 LEDs/each optic 1
 Light colour White
 Required components:
 C13333_MIRELLA-CL

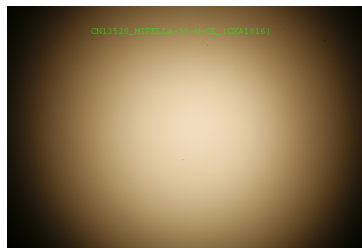

CREE

LED CXA/B 1816 & CXA/B 1820 & CXA 1850
 FWHM 52.0°
 Efficiency 82 %
 Peak intensity 1.200 cd/lm
 LEDs/each optic 1
 Light colour White
 Required components:
 C12479_MIRELLA-DL

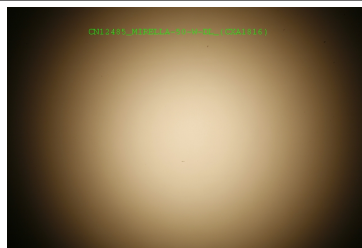

CREE

LED CXA/B 1816 & CXA/B 1820 & CXA 1850
 FWHM 52.0°
 Efficiency 87 %
 Peak intensity 1.200 cd/lm
 LEDs/each optic 1
 Light colour White
 Required components:

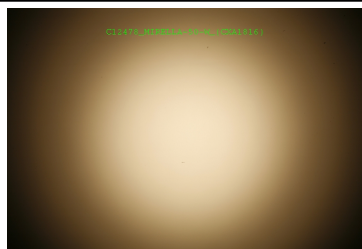

PHOTOMETRIC DATA (MEASURED):

CREE 

LED MHD-E/G
 FWHM 50.0°
 Efficiency 87 %
 Peak intensity 1.100 cd/lm
 LEDs/each optic 1
 Light colour White
 Required components:
 C13333_MIRELLA-CL

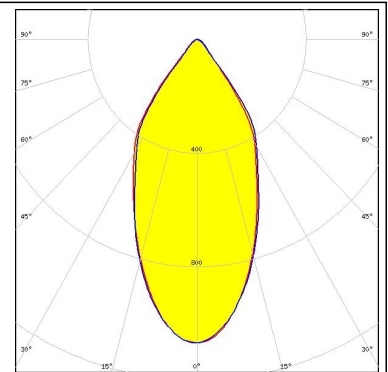
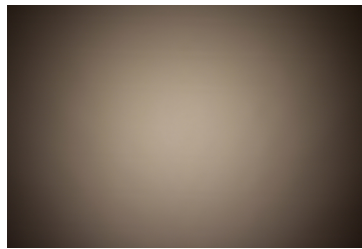

CREE 

LED MHD-E/G
 FWHM 52.0°
 Efficiency 87 %
 Peak intensity 1.000 cd/lm
 LEDs/each optic 1
 Light colour White
 Required components:
 C12479_MIRELLA-DL

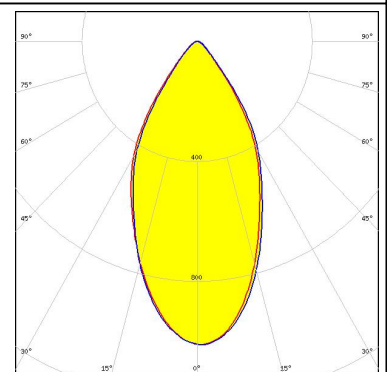
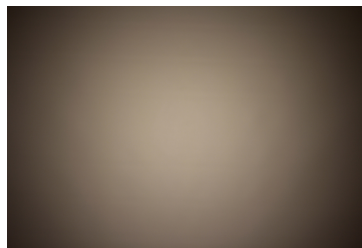

CREE 

LED MHD-E/G
 FWHM 46.0°
 Efficiency 92 %
 Peak intensity 1.200 cd/lm
 LEDs/each optic 1
 Light colour White
 Required components:

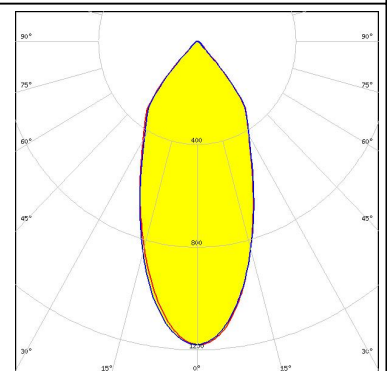
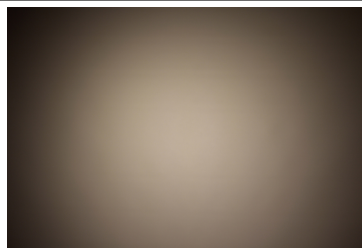

CREE 

LED MT-G
 FWHM 46.0°
 Efficiency 90 %
 Peak intensity 1.253 cd/lm
 LEDs/each optic 1
 Light colour White
 Required components:

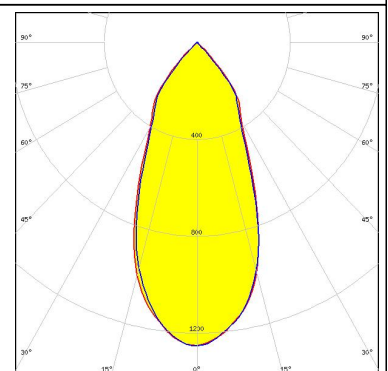

PHOTOMETRIC DATA (MEASURED):

CREE 

LED MT-G2
 FWHM 52.0°
 Efficiency 83 %
 Peak intensity 1.100 cd/lm
 LEDs/each optic 1
 Light colour White
 Required components:
 C12479_MIRELLA-DL

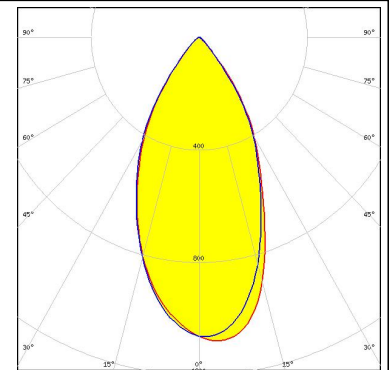

CREE 

LED MT-G2
 FWHM 50.0°
 Efficiency 84 %
 Peak intensity 1.100 cd/lm
 LEDs/each optic 1
 Light colour White
 Required components:
 C13333_MIRELLA-CL

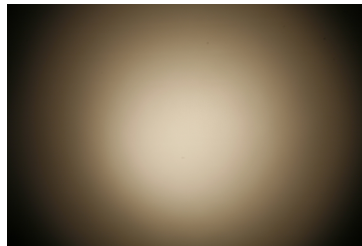

CREE 

LED MT-G2
 FWHM 46.0°
 Efficiency 91 %
 Peak intensity 1.400 cd/lm
 LEDs/each optic 1
 Light colour White
 Required components:

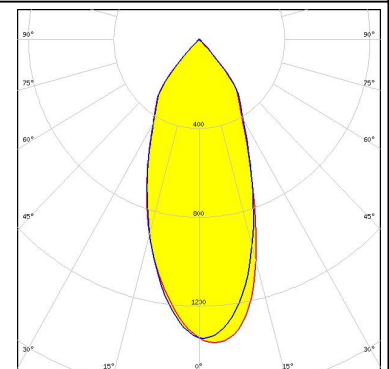

CREE 

LED XHP50
 FWHM 48.0°
 Efficiency 85 %
 Peak intensity 1.100 cd/lm
 LEDs/each optic 1
 Light colour White
 Required components:
 C12479_MIRELLA-DL

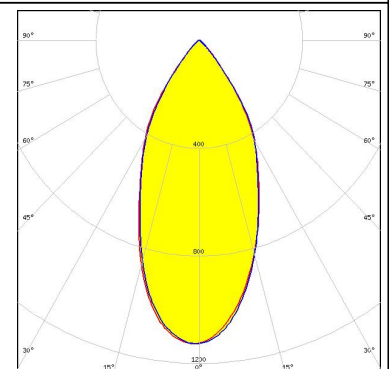
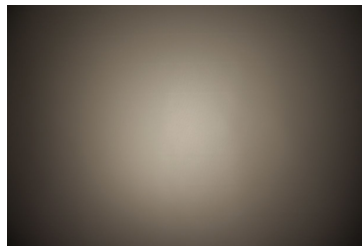

PHOTOMETRIC DATA (MEASURED):



LED XHP50
 FWHM 45.0°
 Efficiency 89 %
 Peak intensity 1.200 cd/lm
 LEDs/each optic 1
 Light colour White
 Required components:

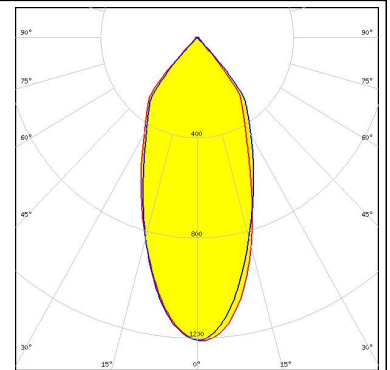
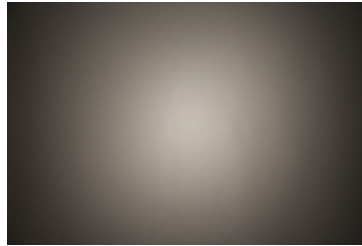

LED XHP50
 FWHM 45.0°
 Efficiency 84 %
 Peak intensity 1.200 cd/lm
 LEDs/each optic 1
 Light colour White
 Required components:
 C13333_MIRELLA-CL

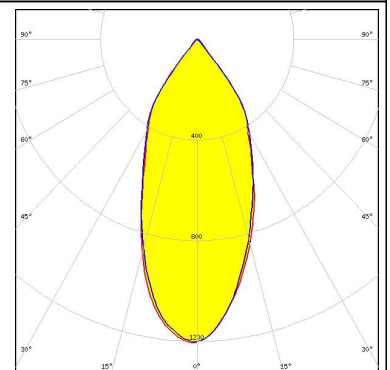
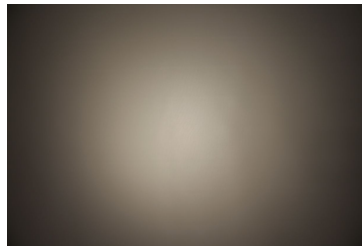

LED XHP70
 FWHM 45.0°
 Efficiency 89 %
 Peak intensity 1.200 cd/lm
 LEDs/each optic 1
 Light colour White
 Required components:

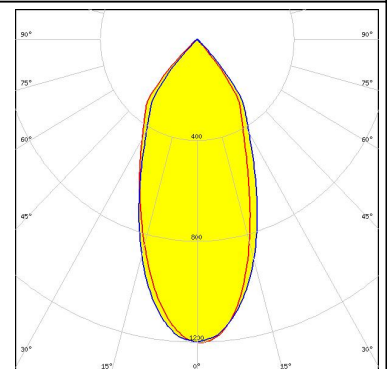
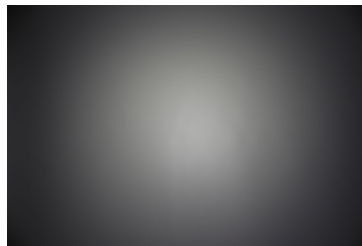

LED XHP70
 FWHM 53.0°
 Efficiency 84 %
 Peak intensity 1.000 cd/lm
 LEDs/each optic 1
 Light colour White
 Required components:
 C13333_MIRELLA-CL

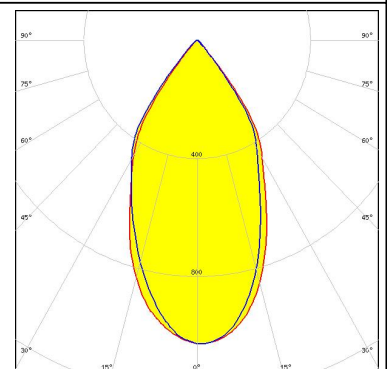
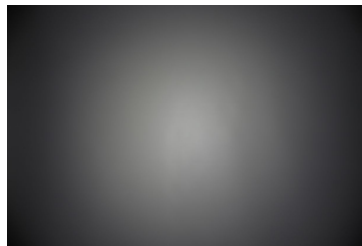

PHOTOMETRIC DATA (MEASURED):



LED XHP70
FWHM 54.0°
Efficiency 84 %
Peak intensity 1.000 cd/lm
LEDs/each optic 1
Light colour White
Required components:
C12479_MIRELLA-DL

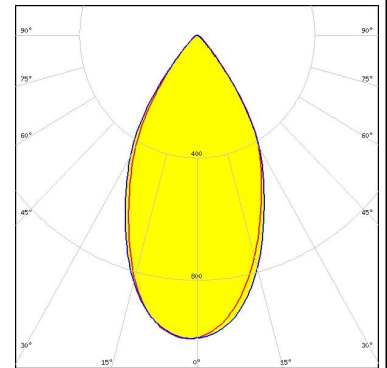
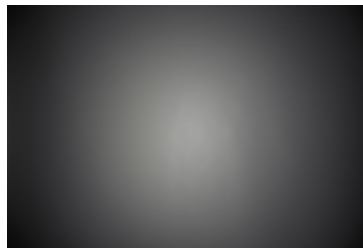

LED COB 4W
FWHM 38.0°
Efficiency 89 %
Peak intensity 1.700 cd/lm
LEDs/each optic 1
Light colour White
Required components:

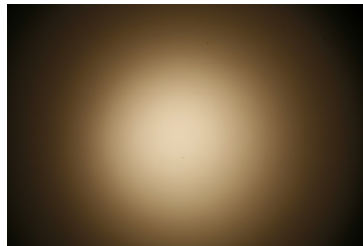



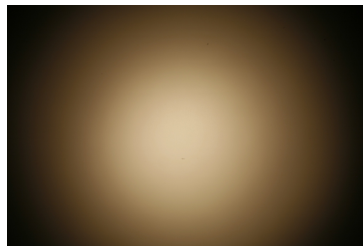

LED COB 4W
FWHM 44.0°
Efficiency 83 %
Peak intensity 1.300 cd/lm
LEDs/each optic 1
Light colour White
Required components:
C12479_MIRELLA-DL

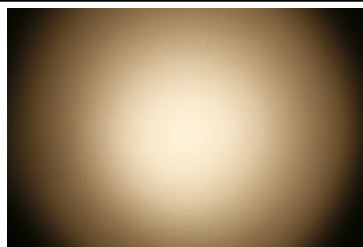

LED COB 4W
FWHM 41.0°
Efficiency 84 %
Peak intensity 1.500 cd/lm
LEDs/each optic 1
Light colour White
Required components:
C13333_MIRELLA-CL

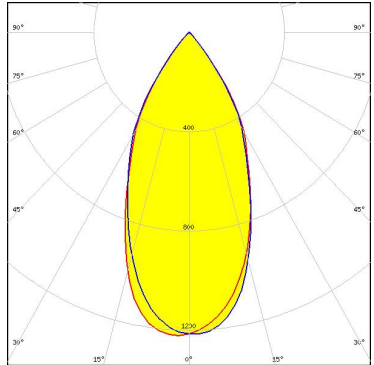
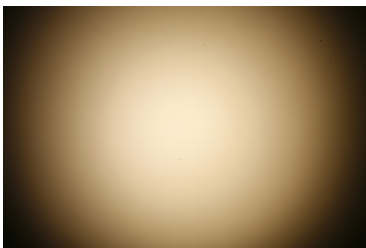
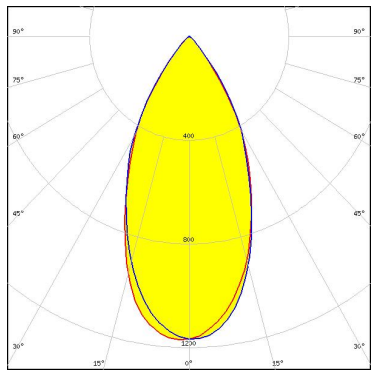

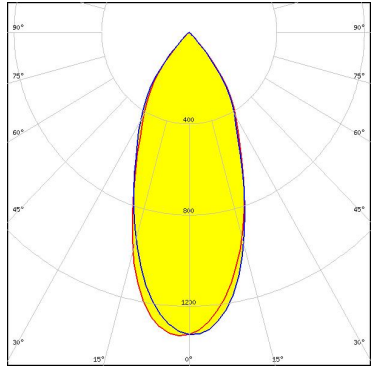
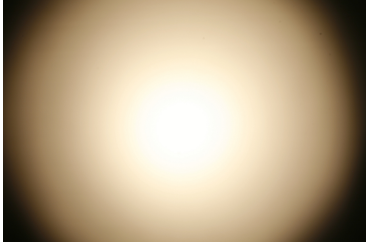
PHOTOMETRIC DATA (MEASURED):

<p>LUMILEDS</p> <p>LED LUXEON CoB 1202/1203 FWHM 49.0° Efficiency 84 % Peak intensity 1.200 cd/lm LEDs/each optic 1 Light colour White Required components: C13333_MIRELLA-CL</p>		
<p>LUMILEDS</p> <p>LED LUXEON CoB 1202/1203 FWHM 50.0° Efficiency 84 % Peak intensity 1.200 cd/lm LEDs/each optic 1 Light colour White Required components: C12479_MIRELLA-DL</p>		
<p>LUMILEDS</p> <p>LED LUXEON CoB 1202/1203 FWHM 44.0° Efficiency 87 % Peak intensity 1.300 cd/lm LEDs/each optic 1 Light colour White Required components:</p>		
<p>LUMILEDS</p> <p>LED LUXEON S1000 FWHM 34.0° Efficiency 84 % Peak intensity 1.700 cd/lm LEDs/each optic 1 Light colour White Required components: C13333_MIRELLA-CL</p>		

PHOTOMETRIC DATA (MEASURED):



LED LUXEON S1000
 FWHM 34.0°
 Efficiency %
 Peak intensity cd/lm
 LEDs/each optic 1
 Light colour White
 Required components:



LED LUXEON S1000
 FWHM 41.0°
 Efficiency %
 Peak intensity cd/lm
 LEDs/each optic 1
 Light colour White
 Required components:
 C12479_MIRELLA-DL

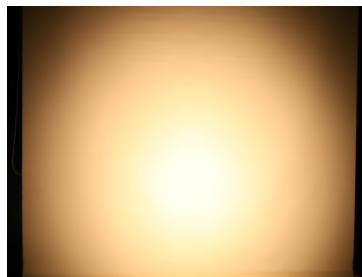

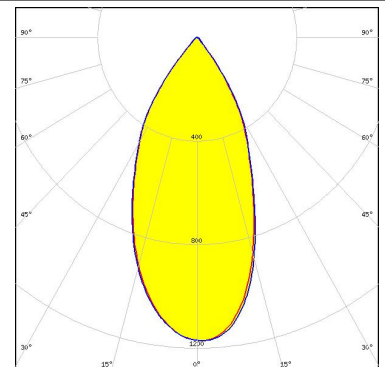
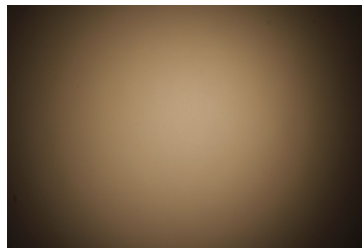

LED CXM-9
 FWHM 48.0°
 Efficiency 83 %
 Peak intensity 1.200 cd/lm
 LEDs/each optic 1
 Light colour White
 Required components:
 C13333_MIRELLA-CL



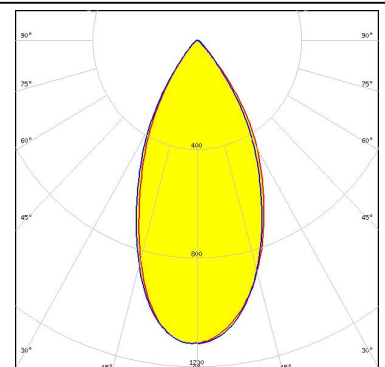
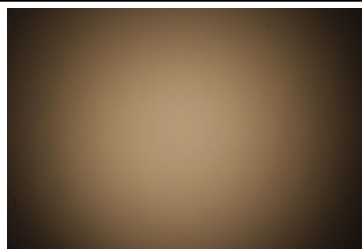

LED CXM-9
 FWHM 49.0°
 Efficiency 83 %
 Peak intensity 1.100 cd/lm
 LEDs/each optic 1
 Light colour White
 Required components:
 C12479_MIRELLA-DL

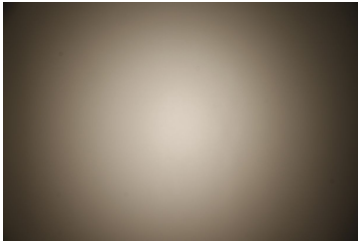
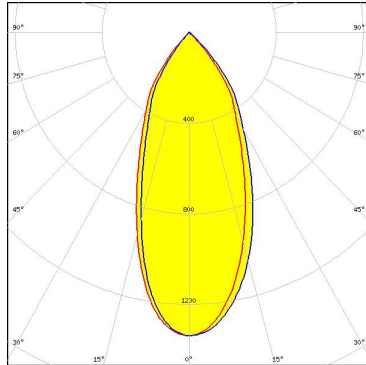
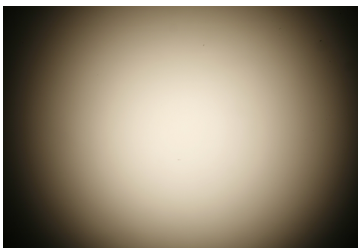
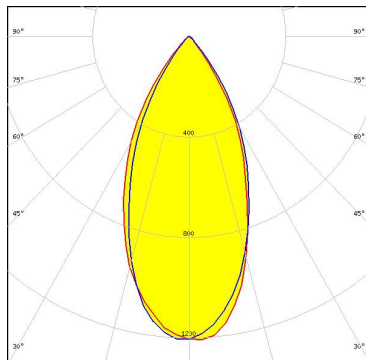

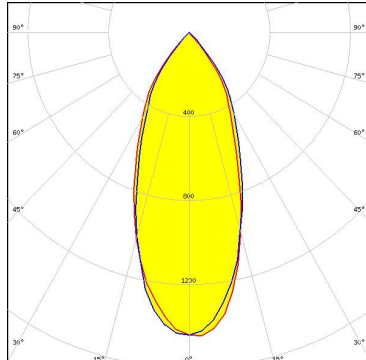
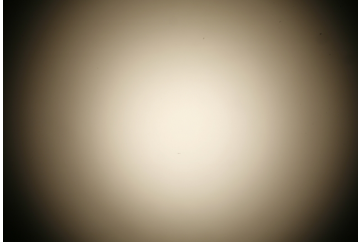
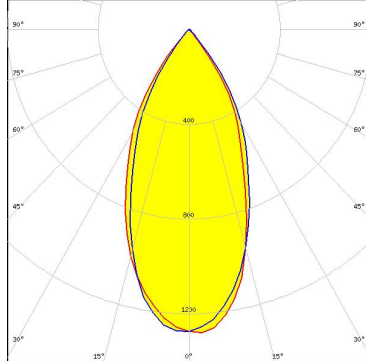
PHOTOMETRIC DATA (MEASURED):

<p>LUMINUS</p> <p>LED CXM-9 FWHM 43.0° Efficiency 89 % Peak intensity 1.300 cd/lm LEDs/each optic 1 Light colour White Required components:</p>		
<p>NICHIA</p> <p>LED COB L-Type (LES 9) FWHM 48.0° Efficiency 83 % Peak intensity 1.200 cd/lm LEDs/each optic 1 Light colour White Required components: C12479_MIRELLA-DL</p>		
<p>NICHIA</p> <p>LED COB L-Type (LES 9) FWHM 42.0° Efficiency 89 % Peak intensity 1.400 cd/lm LEDs/each optic 1 Light colour White Required components:</p>		
<p>NICHIA</p> <p>LED COB L-Type (LES 9) FWHM 47.0° Efficiency 85 % Peak intensity 1.300 cd/lm LEDs/each optic 1 Light colour White Required components: C13333_MIRELLA-CL</p>		

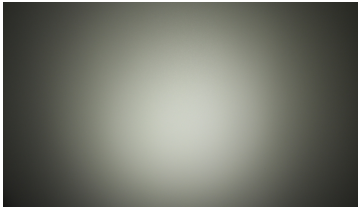
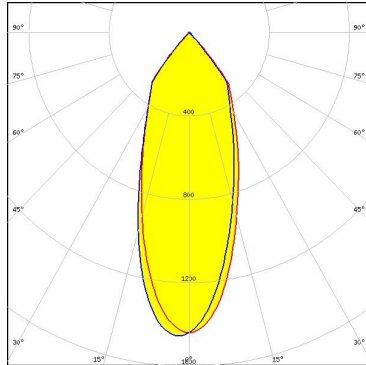
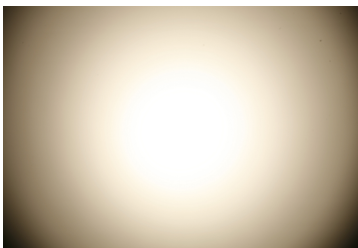
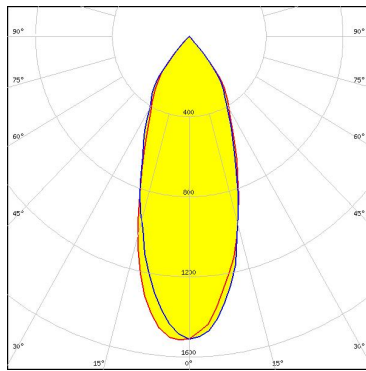

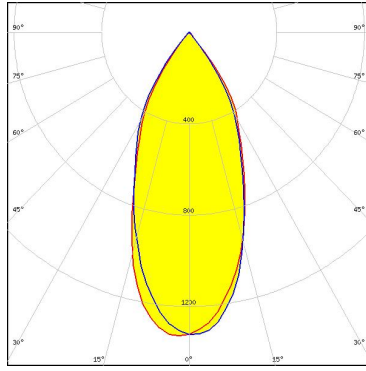
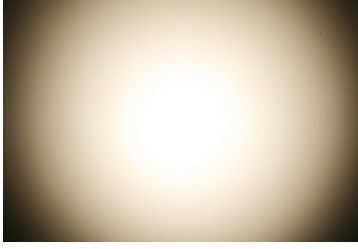
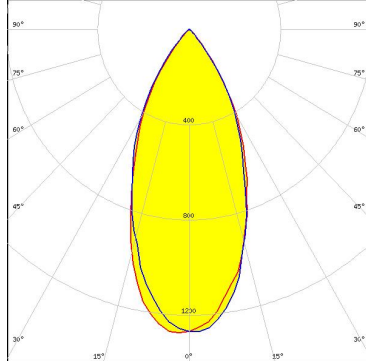
PHOTOMETRIC DATA (MEASURED):

<p>NICHIA</p> <p>LED NFMW48xA FWHM 38.0° Efficiency 88 % Peak intensity 1.500 cd/lm LEDs/each optic 1 Light colour White Required components:</p>		
<p>NICHIA</p> <p>LED NSCxL036A FWHM 40.0° Efficiency 87 % Peak intensity 1.500 cd/lm LEDs/each optic 1 Light colour White Required components:</p>		
<p>NICHIA</p> <p>LED NSCxL036A FWHM 44.0° Efficiency 83 % Peak intensity 1.300 cd/lm LEDs/each optic 1 Light colour White Required components: C13333_MIRELLA-CL</p>		
<p>NICHIA</p> <p>LED NSCxL036A FWHM 46.0° Efficiency 83 % Peak intensity 1.300 cd/lm LEDs/each optic 1 Light colour White Required components: C12479_MIRELLA-DL</p>		

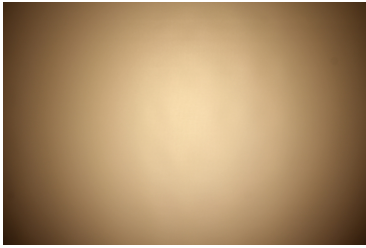
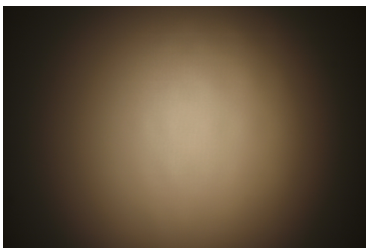
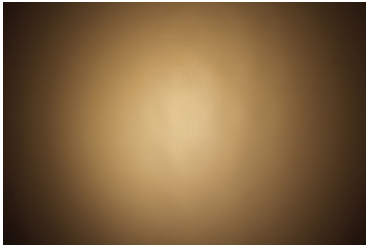
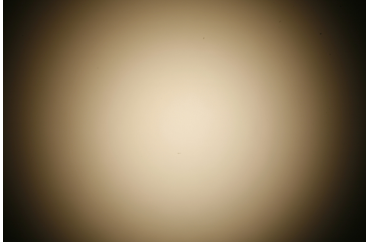
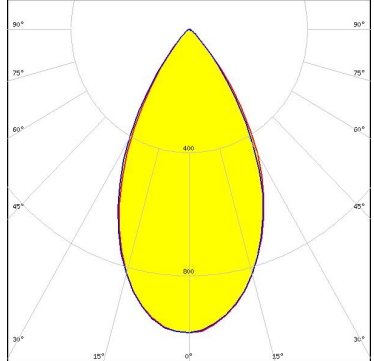

PHOTOMETRIC DATA (MEASURED):

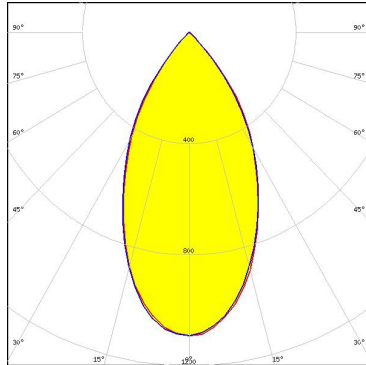
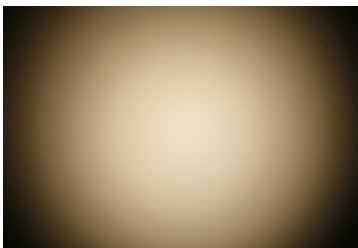
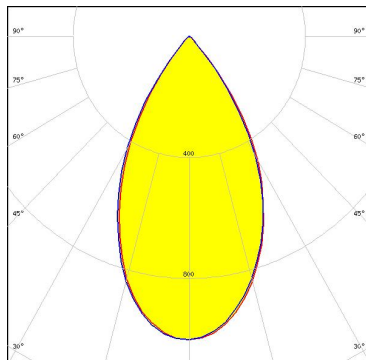
<p>OSRAM Opto Semiconductors</p> <p>LED Duris S10 FWHM 49.0° Efficiency 79 % Peak intensity 1.100 cd/lm LEDs/each optic 1 Light colour White Required components: C12479_MIRELLA-DL</p>	
<p>OSRAM Opto Semiconductors</p> <p>LED Duris S10 FWHM 40.0° Efficiency 87 % Peak intensity 1.500 cd/lm LEDs/each optic 1 Light colour White Required components:</p>	
<p>OSRAM Opto Semiconductors</p> <p>LED Duris S10 FWHM 45.0° Efficiency 82 % Peak intensity 1.300 cd/lm LEDs/each optic 1 Light colour White Required components: C13333_MIRELLA-CL</p>	
<p>OSRAM Opto Semiconductors</p> <p>LED Soleriq S13 FWHM 57.0° Efficiency 81 % Peak intensity 1.000 cd/lm LEDs/each optic 1 Light colour White Required components: C12479_MIRELLA-DL</p>	 

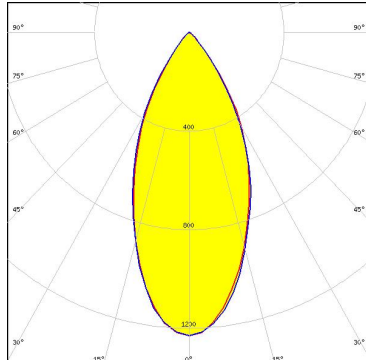
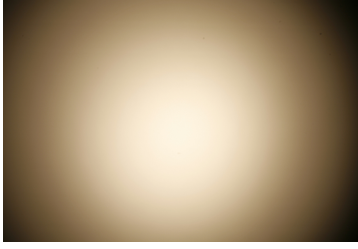
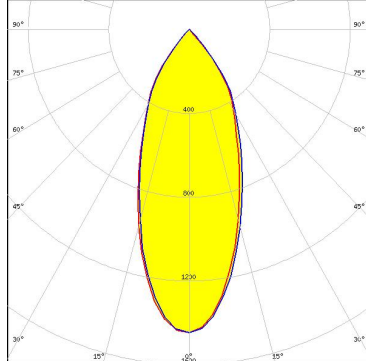
PHOTOMETRIC DATA (MEASURED):

<p>OSRAM Opto Semiconductors</p> <p>LED Soleriq S13 FWHM 55.0° Efficiency 85 % Peak intensity cd/lm LEDs/each optic 1 Light colour White Required components:</p>		
<p>OSRAM Opto Semiconductors</p> <p>LED Soleriq S13 FWHM 57.0° Efficiency 80 % Peak intensity 1.000 cd/lm LEDs/each optic 1 Light colour White Required components: C13333_MIRELLA-CL</p>		
<p>SEOL SEOUL SEMICONDUCTOR</p> <p>LED ZC4/6 FWHM 48.0° Efficiency 81 % Peak intensity 1.200 cd/lm LEDs/each optic 1 Light colour White Required components: C12479_MIRELLA-DL</p>		
<p>SEOL SEOUL SEMICONDUCTOR</p> <p>LED ZC4/6 FWHM 42.0° Efficiency 86 % Peak intensity 1.400 cd/lm LEDs/each optic 1 Light colour White Required components:</p>		

PHOTOMETRIC DATA (MEASURED):

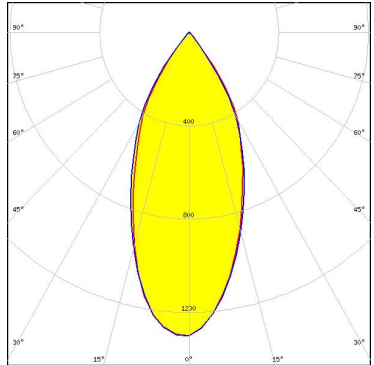
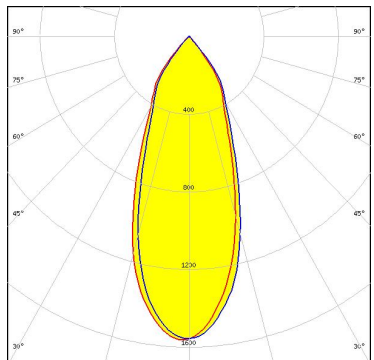
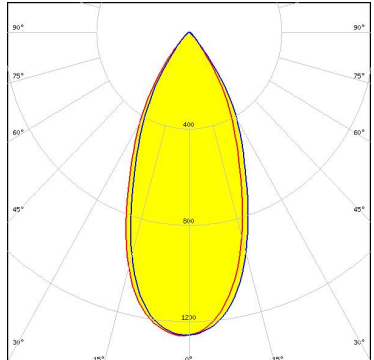
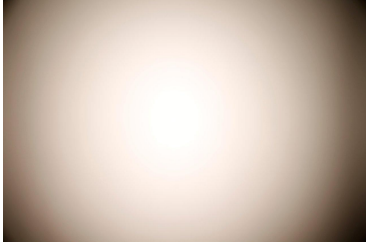
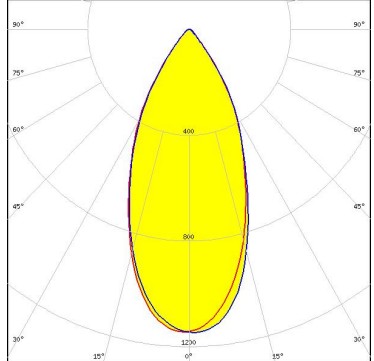
<p> SEUL SEMICONDUCTOR</p> <p>LED ZC4/6 FWHM 46.0° Efficiency 80 % Peak intensity 1.300 cd/lm LEDs/each optic 1 Light colour White Required components: C13333_MIRELLA-CL</p>		
<p>SHARP</p> <p>LED Mini Zenigata (GW5BM) FWHM 39.0° Efficiency 89 % Peak intensity 1.500 cd/lm LEDs/each optic 1 Light colour White Required components:</p>		
<p>SHARP</p> <p>LED Mini Zenigata (GW5BM) FWHM 45.0° Efficiency 84 % Peak intensity 1.260 cd/lm LEDs/each optic 1 Light colour White Required components: C12479_MIRELLA-DL</p>		
<p>SHARP</p> <p>LED Mini Zenigata (GW6BM) FWHM 45.0° Efficiency 81 % Peak intensity 1.100 cd/lm LEDs/each optic 1 Light colour White Required components: C12479_MIRELLA-DL</p>		

PHOTOMETRIC DATA (MEASURED):

SHARP

LED Mini Zenigata (GW6BM)
FWHM 38.0°
Efficiency 88 %
Peak intensity 1.500 cd/lm
LEDs/each optic 1
Light colour White
Required components:

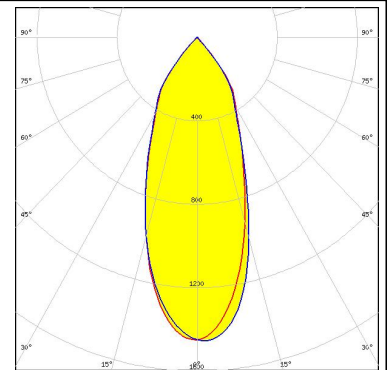
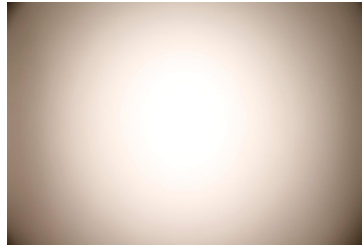

TRIDONIC

LED SLE G5 LES11
FWHM 49.0°
Efficiency 86 %
Peak intensity 1.150 cd/lm
LEDs/each optic 1
Light colour White
Required components:

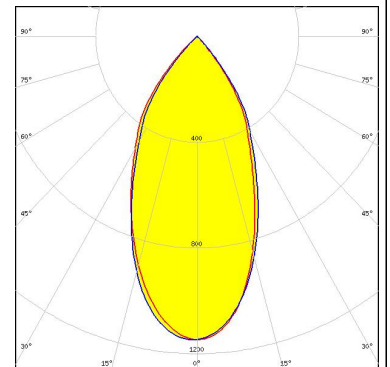
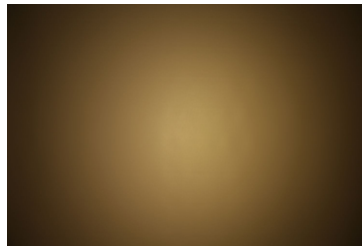

TRIDONIC

LED SLE G5 LES6
FWHM 39.0°
Efficiency 88 %
Peak intensity 1.450 cd/lm
LEDs/each optic 1
Light colour White
Required components:

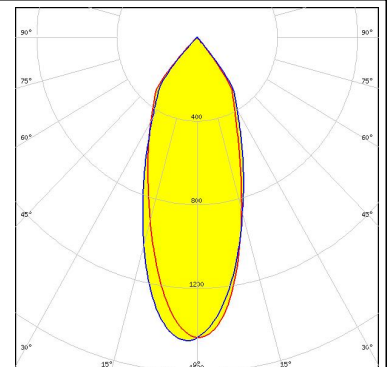
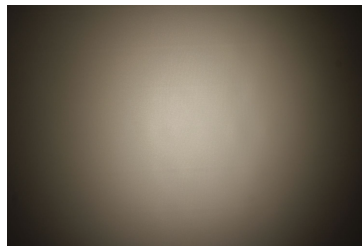

PHOTOMETRIC DATA (SIMULATED):

<p>OSRAM Opto Semiconductors</p> <p>LED OSCONIQ P 7070</p> <p>FWHM 45.0°</p> <p>Efficiency 91 %</p> <p>Peak intensity 1.400 cd/lm</p> <p>LEDs/each optic 1</p> <p>Light colour White</p> <p>Required components:</p>	
<p>OSRAM Opto Semiconductors</p> <p>LED Soleriq S9</p> <p>FWHM 51.0°</p> <p>Efficiency 85 %</p> <p>Peak intensity 1.100 cd/lm</p> <p>LEDs/each optic 1</p> <p>Light colour White</p> <p>Required components: C12479_MIRELLA-DL</p>	
<p>OSRAM Opto Semiconductors</p> <p>LED Soleriq S9</p> <p>FWHM 51.0°</p> <p>Efficiency 85 %</p> <p>Peak intensity 1.100 cd/lm</p> <p>LEDs/each optic 1</p> <p>Light colour White</p> <p>Required components: C13723_MIRELLA-RZL</p>	
<p>OSRAM Opto Semiconductors</p> <p>LED Soleriq S9</p> <p>FWHM 47.0°</p> <p>Efficiency 91 %</p> <p>Peak intensity 1.300 cd/lm</p> <p>LEDs/each optic 1</p> <p>Light colour White</p> <p>Required components:</p>	

PHOTOMETRIC DATA (SIMULATED):

OSRAM
Opto Semiconductors

LED Soleriq S9
FWHM 50.0°
Efficiency 87 %
Peak intensity 1.200 cd/lm
LEDs/each optic 1
Light colour White
Required components:
C13333_MIRELLA-CL

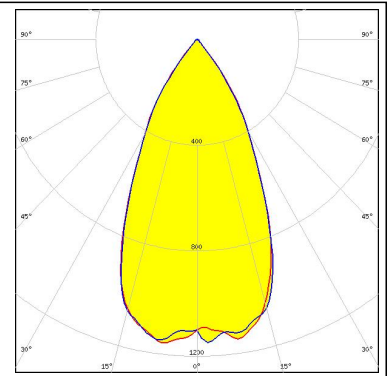

GENERAL INFORMATION:

NOTE: The typical beam angle will be changed by different color, chip size and chip position tolerance. The typical total beam angle is the full angle measured where the luminous intensity is half of the peak value.

Due to use of high power COB's with this product, special attention to proper thermal design is highly recommended. LEDiL has no liability for direct, indirect or consecutive damages arising from the LEDiL products being used outside of the recommended temperature range.

MATERIALS:

As part of our continuous research and improvement processes, and to ensure the best possible quality and availability of our products, LEDiL reserves the right to change material grades without notice.

PRODUCT DATA USER AGREEMENT AND DISCLAIMER:

The measured data in the provided downloadable LEDiL Product Datasheets and Mechanical 2D-Drawings is rounded and provided as reference for planning. LEDiL Oy's optical specifications have been verified by conducting performance testing of the products in accordance with the company's quality system. The reported data are averaged results of multiple measurements with typical variation. LEDiL Oy reserves the right to without prior notification make changes and improvements to its products.

LEDiL Oy assumes neither warranty, nor guarantee nor any other liability of any kind for the contents and correctness of the provided data. The provided data has been generated with highest diligence but the provided data may in reality not represent the complete possible variation range of all intrinsic parameters. Therefore, in certain cases a deviation from the provided data could occur.

LEDiL Oy reserves the right to undertake technical changes of its products without further notification which could lead to changes in the provided data. LEDiL Oy assumes no liability of any kind for the possible deviation from any provided data or any other damage resulting from the usage of the provided data.

The user agrees to this disclaimer and user agreement with the download or usage of the provided files.

LEDiL Oy

Joensuunkatu 13
FI-24240 SALO
Finland

LEDiL Inc.

228 West Page Street
Suite D
Sycamore IL 60178
USA

Local sales and technical support

[www.ledil.com/
where_to_buy](http://www.ledil.com/where_to_buy)

Shipping locations

Salo, Finland
Hong Kong, China

Distribution Partners

[www.ledil.com/
where_to_buy](http://www.ledil.com/where_to_buy)